

LUMEL

MULTIFUNCTION DC ENERGY METER N18H



SERVICE MANUAL

MULTIFUNCTION DC ENERGY METER

N18H

Section	Contents
1.	Introduction
2.	Measurement Reading Screens
	2.1 Timer Screen
	2.2 Number of Interruptions
	2.3 On-hour
	2.4 Run-hour
	2.5 Date and time
3.	Installation
	3.1 EMC installation requirements
	3.2 Case Dimensions and Panel Cut-out
	3.3 Wiring
	3.4 Auxiliary Supply
	3.5 Fusing
	3.6 Earth/Ground Connections
4.	Connection Diagram
5.	Parameter Editing Guide
6.	Setup Screens (Flowchart)
7.	Programming
	7.1 Password Protection
	7.2 System Parameter Selection Screen
	7.2.1 Auto Voltage Detection
	7.2.2 Nominal Voltage
	7.2.3 Channel Selection
	7.2.4 Current Full Scale value
	7.2.5 Current Shunt value
	7.2.6 Demand Integration Time
	7.2.7 Energy Rate
	7.2.8 Reverse Locking
	7.2.9 Auto Scrolling
	7.2.10 Noise Current
	7.2.11 Energy Output
	7.2.12 Energy Digit Reset Count

- 7.3 Communication Parameter Selection Screen
 - 7.3.1 Address Setting
 - 7.3.2 Baud rate
 - 7.3.3 Parity selection
- 7.4 Reset Parameter Selection Screen
- 7.5 Output Option selection Screen
 - 7.5.1 Select Relay Output
 - 7.5.1.1 Limit Relay Configuration
 - 7.5.1.1.1 Limit Parameter
 - 7.5.1.1.2 Limit Configuration
 - 7.5.1.1.3 Trip Point
 - 7.5.1.1.4 Hysteresis
 - 7.5.1.1.5 Energising Delay
 - 7.5.1.1.6 De-energising Delay
 - 7.5.1.2 Pulse Relay Configuration
 - 7.5.1.2.1 Pulse Parameter
 - 7.5.1.2.2 Pulse Divisor
 - 7.5.1.2.3 Pulse Duration
 - 7.5.1.3 Timer Relay Configuration
 - 7.5.1.3.1 Number of Cycles
 - 7.5.1.3.2 Timer Configuration
 - 7.5.1.3.3 On Delay
 - 7.5.1.3.4 Off Delay
 - 7.5.1.4 Remote Operation
 - 7.5.1.5 Reverse Locking Relay
 - 7.5.1.5.1 Parameter Selection
 - 7.5.1.5.2 Relay Configuration
 - 7.5.1.5.3 On Delay
 - 7.5.1.5.4 Off Delay
 - 7.5.1.6 RTC Relay
 - 7.5.1.6.1 Weekdays Selection
 - 7.5.1.6.2 Relay Configuration
 - 7.5.1.6.3 On Time
 - 7.5.1.6.4 Off Time

- 7.6 RTC Setup Selection Screen
 - 7.6.1 RTC Date Setup
 - 7.6.2 RTC Time Setup
- 7.7 Datalog Setup Selection Screen
 - 7.7.1 Event Datalog Setup
 - 7.7.1.1 Event Datalog Start/Stop
 - 7.7.2 Time Datalog Setup
 - 7.7.2.1 Time Datalog Start/Stop
 - 7.7.2.2 Interval Selection
 - 7.7.2.3 Parameter Count
 - 7.7.2.4 Parameter Selection
 - 7.7.3 Load Profile Setup
 - 7.7.3.1 Datalog Channel Selection
- 7.8 User Assignable screens Setup
 - 7.8.1 No. of Userscreens
 - 7.8.1.1 User Screen no. Selection
- 7.9 Factory Reset Selection Screen
 - 7.9.1 Factory Reset Confirmation
- 8. Relay Output
 - 8.1 Limit Relay
 - 8.2 Pulse Output
 - 8.3 Timer Output
- 9. Specification
- 10. Connection for Optional Pulse output / RS 485 / USB

1. Introduction

The Multifunction DC Energy Meter is a panel mounted 96 x 96mm DIN Quadratic Digital Panel Meter, which measures important electrical parameters in DC Network and replaces the multiple analog panel meters. It measures electrical parameters like DC voltage, Current, Power, Energy (Import & Export), Demand & many more. The meter can be used for upto 4 channels. It integrates accurate measurement technology with bright LED display (8 digit x 4).

The meter can be configured on site for various parameters including Nominal Voltage, Current Full scale Setting, Current Shunt Settings, No. of channels, Demand Integration Time etc.

The front panel has three push buttons using which the user can scroll through different screens & configure the product. It also includes 20 LEDs which in conjunction with LED display, provides information in different units and gives overview of channel status.

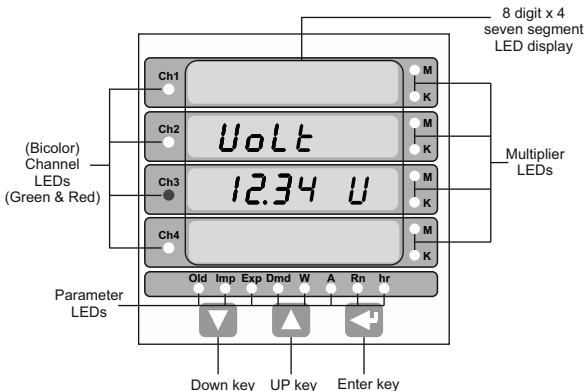

The channel LEDs serve many purposes. In setup menus, if a channel parameter is being displayed one of them glows green according to the displayed channel parameter. In measurement screens, they change color according to channel status i.e. healthy, alarm and overload conditions. Overload condition is defined as measured value > 126% of nominal value. Refer following points to decode the information that the LED provides. These points are true for measured parameters i.e. voltage and current.

- The LED glows green in healthy condition and becomes red in overload condition.
- If a limit relay is assigned to the channel, the LED will glow red if alarm condition is true and will glow green if healthy condition is observed.

For derived parameters (power, energy, ampere-hour and demands), following points are applicable.

- When the voltage and current both are healthy, the LED will glow green. If one of the parameters(voltage or current) is in overload condition, LEDs for all the derived parameter calculated from that value will also turn red.
- If a limit is assigned to the parameter, the LED will glow red in alarm condition and green in healthy condition.

When more than one from the above conditions are applicable, the LEDs will follow "OR" logic for alarm condition and "AND" logic for healthy condition, i.e. it will glow red when even one of the alarm conditions is true and it will only glow green when all of the healthy conditions are true.

There are two multiplier LEDs for each channel marked K(kilo 10^3) and M(mega 10^6). Each will glow red according to the scaling required to the value on display.

One or more from the parameter LEDs will glow red according to the parameter displayed on the screen.

2. Measurement Reading Screens

In normal operation, the meter shows one of the measurement reading screens out of several screens. These screens may be scrolled through one at a time in incremental order by pressing the "UP key" or in decremental order by pressing the "DOWN key".

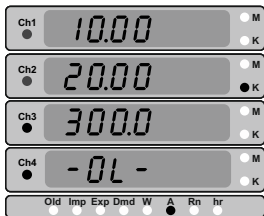

An example of the current screen is shown in the picture. The values read as,

Channel 1: 10 A

Channel 2: 20000 A(20×10^3)

Channel 3: 300 A

Channel 4: Overload condition

The channel LED for channel 1 and 2 is glowing green which means they are in healthy condition.

The channel 3 LED is glowing red and a measured value is being displayed, which means that there is a limit relay set on this channel and alarm condition is present.

The channel 4 LED is red with -OL- displayed on screen which means that the measured current on this channel is above 126% of nominal value set.

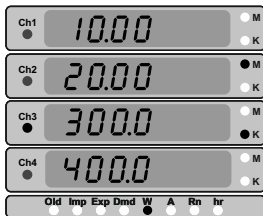

An example of the power screen is shown in the picture. The values read as,

Channel 1: 10 W

Channel 2: 20000000 W(20×10^6)

Channel 3: 300000 W(300×10^3)

Channel 4: Overload condition

The channel LED for channel 1 and 2 is glowing green which means they are in healthy condition.

The channel 3 LED is glowing red and a measured value is being displayed, which means one from the following conditions is present

- 1) There is a limit relay set on this channel and alarm condition is present.
- 2) Any one from voltage or channel 3 current is in overload condition.

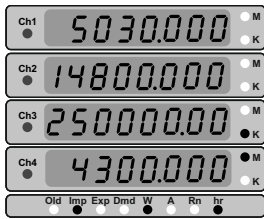

Import Energy Screen

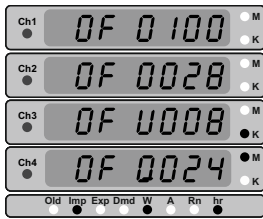

Import Energy Overflow Screen

Shown above are the import energy screens. The display of the meter can only accommodate 8 digits. So to display more than 8 digit energy, an overflow screen is added. When the energy reaches the energy digit reset count, it starts the count from 0 again. When this happens the corresponding overflow is increased by 1. The maximum value of the overflow is 2000 for individual channels. Thus the highest energy that the meter can show is 200099999999 Mwh. To obtain the value for current energy reading, the user need to multiply the overflow count by 10 raised to energy digit reset count for the corresponding channel and add the result in displayed energy reading.

Example: In the screens shown above, assume that the energy digit reset count for the channels are 8 7 6 and 8 respectively. So the energy reading for each channel will be as following:

Channel 1: $[(100 \times 10^8) + 5030] = 1000005030 \text{ Wh}$

Channel 2: $[(28 \times 10^7) + 14800] = 280014800 \text{ Wh}$

Channel 3: $[(8 \times 10^6) + 250000] = 8250000 \text{ kWh}$

Channel 4: $[(24 \times 10^8) + 4300] = 2400004300 \text{ Mwh}$

The overflow value will start counting from 0 after reaching 2000. For total parameters with overflow this limit is 8000.

Note: - DC EM measures positive & negative Voltage, Current and it's derived parameters.

2.1 Timer Screen

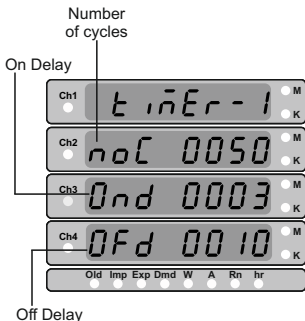

As shown in the picture above, there are upto four timer screens present in measurement screens. They show values of number of cycles, on delay and off delay for corresponding timer. When timer is running, these values are shown in countdown mode.

If number of cycles is set as 0, then on this screen number of cycles will always increment from 0 up to 9999.

Note :- 1. Press UP key to start the timer.

2. Press down key to stop the timer.

Timer Unused :- Timer is not selected as a relay output.

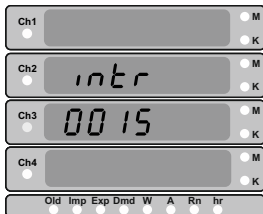

2.3 On-hour



This screen shows the total number of hours the auxiliary supply has stayed on. Even if the Auxiliary supply is interrupted count of on hour will be maintained in internal memory & displayed in the "hhhhhh.mm" format. For example if displayed count is 105000.10 it indicates 105000 hours and 10 minutes. After 999999.59 On hours display will restart from zero. The user can reset this value in reset parameters menu.

2.2 Number of Interruptions

This screen shows the number of power supply interruptions that the meter has encountered. After 9999 this value will start its count from 0. User can reset this count in the reset menu.

2.4 Run Hour



This Screen shows the total no. of hours each of the load has been connected. Even if the Auxiliary supply is interrupted, count of Run hour will be maintained in internal memory & displayed in the format "hhhhh.mm".

For example if Displayed count is 105000.10 it indicates 105000 hours & 10 minutes. After 999999.59 run hours display will restart from zero. The user can reset these values in reset parameters menu.

2.5 Date and Time



This screen shows the RTC date and time in dd-mm-yy and hh.mm format respectively. The user can change these values in RTC setup menu.

Table-1

Measured Parameter	Ch1	Ch2	Ch3	Ch4	Σ	Min	Max	Measuring range	Displaying range	Accuracy
Voltage			●			●	●	±10~ ± 60VDC ±61~ ±200 VDC ±201~± 1000VDC	0- ±9999	± 0.5% of nominal value
Current	●	●	●	●		●	●	50-150mV	0- ±9999	±0.5 % of nominal value
Power (Import & Export)	●	●	●	●	●			0- ±1.2MW / Ch 0- ±4.0MW / Ch 0- ±20 MW / Ch	0- ±9999	1% of nominal value
Energy (Import & Export)	●	●	●	●	●			0-99999999	0-99999999	Class1
AmpereHour (Import & Export)	●	●	●	●	●			0-99999999	0-99999999	-
Demand (Import&Export)	●	●	●	●	●		●	0- ± 1.2MW 0- ±4 MW 0- ±20MW	0- 9999	-
Current Demand(Import&Export)	●	●	●	●	●		●	50-150mV	0- 9999	-
On Hour			●					999999.59	999999.59	-
Run Hour	●	●	●	●				999999.59	999999.59	-
Number of Interruptions			●					0-9999	0-9999	-

TABLE : 2 Measurement Screen Parameters

Screen No.	Screen Name	Parameter LED Status (N18H-A)	Parameter LED Status (N18H-Z)
1	Voltage	None	None
2	Current - Ch1 Ch2 Ch3 Ch4	A	A
3	Power - Ch1 Ch2 Ch3 Ch4	W	W
4	Total Import Power	Imp,W	Imp,W
5	Total Export Power	Exp,W	Exp,W
6	Import Energy Ch1 - CH4	Imp,W,hr	Imp,W,hr
7	Import Energy Overflow Count	Imp,W,hr	Imp,W,hr
8	Export Energy Ch1 - Ch4	Exp,W,hr	Exp,W,hr
9	Export Energy Overflow Count	Exp,W,hr	Exp,W,hr
10	Total Import Energy	Imp,W,hr	Imp,W,hr
11	Total Export energy	Exp,W,hr	Exp,W,hr
12	Import A-Hr Ch1 - Ch4	Imp,A,hr	Imp,A,hr
13	Import A-Hr Ch1- Ch4 OF Count	Imp,A,hr	Imp,A,hr
14	Export A-Hr Ch1 - Ch4	Exp,A,hr	Exp,A,hr
15	Export A-Hr Ch1 - Ch4 OF Count	Exp,A,hr	Exp,A,hr
16	Total Import A-Hr	Imp,A,hr	Imp,A,hr
17	Total Export A-Hr	Exp,A,hr	Exp,A,hr
18	Import POWER Demand Ch1 -Ch2 -Ch3 -CH4	Imp,W,Dm	Imp,W,Dm
19	Export POWER Demand Ch1 -Ch2 -Ch3 -CH4	Exp,W,Dm	Exp,W,Dm
20	Total Import Power Demand	Imp,W,Dm	Imp,W,Dm
21	Total Export Power Demand	Exp,W,Dm	Exp,W,Dm
22	Import Current Demand Ch1 -Ch2 -Ch3 -CH4	Imp,A,Dm	Imp,A,Dm
23	Export Current Demand Ch1 -Ch2 -Ch3 -CH4	Exp,A,Dm	Exp,A,Dm
24	Total Import Current Demand	Imp,A,Dm	Imp,A,Dm
25	Total Export Current Demand	Exp,A,Dm	Exp,A,Dm
26	On - hrs	None	None
27	Run - hrs Ch1 --Ch4	Rn - hr	Rn - hr
28	Max Voltage	None	None
29	Min Voltage	None	None
30	MAX Current Ch1 -Ch2 -Ch3 -CH4	A	A
31	Min Current Ch1 -Ch2 -Ch3 -CH4	A	A
32	Import Max POWER Demand Ch1 -Ch2 -Ch3 -CH4	Imp,W,Dm	Imp,W,Dm
33	Export Max POWER Demand Ch1 -Ch2 -Ch3 -CH4	Exp,W,Dm	Exp,W,Dm
34	Import Max Current Demand Ch1 -Ch2 -Ch3 -CH4	Imp,A,Dm	Imp,A,Dm

Continued...

35	Export Max Current Demand Ch1 -Ch2 -Ch3 -CH4	Exp,A,Dm	Exp,A,Dm
36	No of interruptions	None	None
37	Old Import Energy Ch1 ---- Ch4	Imp, W, hr, Old	Imp, W, hr, Old
38	Old Import Energy Ch1 ---- Ch4 OF Count	Imp, W, hr, Old	Imp, W, hr, Old
39	Old Export Energy Ch1 --- Ch4	Exp, W, hr, Old	Exp, W, hr, Old
40	Old Export Energy Ch1 ---- Ch4 OF Count	Exp, W, hr, Old	Exp, W, hr, Old
41	Old A-Hr Imp Ch1 --- Ch4	Old, A, hr, Imp	Old, A, hr, Imp
42	Old A-Hr Imp Ch1 --- Ch4 OF Count	Old, A, hr, Imp	Old, A, hr, Imp
43	Old A-Hr Exp Ch1 ----Ch4	Old, A, hr, Exp	Old, A, hr, Exp
44	Old A-Hr Exp Ch1 ----Ch4 OF Count	Old, A, hr, Exp	Old, A, hr, Exp
45	Old max Imp Power Demand Ch1 - Ch4	Old, W, Dm, Imp	Old, W,Dm, Imp
46	Old max Exp Power Demand Ch1 - Ch4	Old, W, Dm, Exp	Old, W,Dm, Exp
47	Old max Imp Current Demand Ch1 - Ch4	Old, A, Dm, Imp	Old, A,Dm, Imp
48	Old max Exp Current Demand Ch1 - Ch4	Old, A, Dm, Exp	Old, A,Dm, Exp
49	Old No of interruptions	Old	Old
50	Old On - hrs	Old	Old
51	Old Run - hrs Ch1 --Ch4	Old, Rn, hr	Old, Rn, hr
52	Timer1 Screen	none	none
53	Timer2 Screen	none	none
54	Timer3 Screen	none	none
55	Timer4 Screen	none	none
56	RTC Date	none	NA

NOTE : N18H-Z without RTC, USB & Datalogging

TABLE : 3 Datalogging Parameters List

Parameter No.	Parameters
0	Voltage
1	Current Ch1
2	Current Ch2
3	Current Ch3
4	Current Ch4
5	Power Ch1
6	Power Ch2
7	Power Ch3
8	Power Ch4
9	Total Import Power
10	Total export Power
11	Energy Imp Ch1
12	Energy Imp Ch2
13	Energy Imp Ch3
14	Energy Imp Ch4
15	Energy Exp Ch1
16	Energy Exp Ch2
17	Energy Exp Ch3
18	Energy Exp Ch4
19	Total Import Energy
20	Total Export Energy

Parameter No.	Parameters
31	Amp Hour Imp Ch3
32	Amp Hour Imp Ch4
33	Amp Hour Exp Ch1
34	Amp Hour Exp Ch2
35	Amp Hour Exp Ch3
36	Amp Hour Exp Ch4
37	Total Import AH
38	Total Export AH
39	Import Demand Ch1
40	Import Demand Ch2
41	Import Demand Ch3
42	Import Demand Ch4
43	Export Demand Ch1
44	Export Demand Ch2
45	Export Demand Ch3
46	Export Demand Ch4
47	Total Import Power Demand
48	Total Export Power Demand
49	Import Current Demand Ch1
50	Import Current Demand Ch2
51	Import Current Demand Ch3
52	Import Current Demand Ch4
53	Export Current Demand Ch1
54	Export Current Demand Ch2
55	Export Current Demand Ch3
56	Export Current Demand Ch4

TABLE : 3 Continued...

Parameter No	Parameters
57	Total Import Current Demand
58	Total Export Current Demand
59	Max Voltage
60	Min Voltage
61	Max Current Ch1
62	Max Current Ch2
63	Max Current Ch3
64	Max Current Ch4
65	Min Current Ch1
66	Min Current Ch2
67	Min Current Ch3
68	Min Current Ch4
69	Max Import Power Demand Ch1
70	Max Import Power Demand Ch2
71	Max Import Power Demand Ch3
72	Max Import Power Demand Ch4
73	Max Export Power Demand Ch1
74	Max Export Power Demand Ch2
75	Max Export Power Demand Ch3
76	Max Export Power Demand Ch4
77	Max Import Current Demand Ch1
78	Max Import Current Demand Ch2
79	Max Import Current Demand Ch3
80	Max Import Current Demand Ch4
81	Max Export Current Demand Ch1
82	Max Export Current Demand Ch2

Parameter No	Parameters
83	Max Export Current Demand Ch3
84	Max Export Current Demand Ch4
85	Energy Imp Ch1 on update rate
86	Energy Imp Ch2 on update rate
87	Energy Imp Ch3 on update rate
88	Energy Imp Ch4 on update rate
89	Energy Import Ch1 on update rate OF
90	Energy Import Ch2 on update rate OF
91	Energy Import Ch3 on update rate OF
92	Energy Import Ch4 on update rate OF
93	Energy Exp Ch1 on update rate
94	Energy Exp Ch2 on update rate
95	Energy Exp Ch3 on update rate
96	Energy Exp Ch4 on update rate
97	Energy Export Ch1 on update rate OF
98	Energy Export Ch2 on update rate OF
99	Energy Export Ch3 on update rate OF
100	Energy Export Ch4 on update rate OF
101	On Hour
102	Run Hour Ch1
103	Run Hour Ch2
104	Run Hour Ch3
105	Run Hour Ch4
106	No. of Interruptions
107	Old Energy Imp Ch 1
108	Old Energy Imp Ch 2

TABLE : 3 Continued...

Parameter No	Parameters
109	Old Energy Imp Ch 3
110	Old Energy Imp Ch 4
111	Old Energy Import Ch1 OF
112	Old Energy Import Ch2 OF
113	Old Energy Import Ch3 OF
114	Old Energy Import Ch4 OF
115	Old Energy Exp Ch 1
116	Old Energy Exp Ch 2
117	Old Energy Exp Ch 3
118	Old Energy Exp Ch 4
119	Old Energy Export Ch1 OF
120	Old Energy Export Ch2 OF
121	Old Energy Export Ch3 OF
122	Old Energy Export Ch4 OF
123	Old Amp Hour Imp Ch1
124	Old Amp Hour Imp Ch2
125	Old Amp Hour Imp Ch3
126	Old Amp Hour Imp Ch4
127	Old Amp Hour Exp Ch1
128	Old Amp Hour Exp Ch2
129	Old Amp Hour Exp Ch3
130	Old Amp Hour Exp Ch4
131	Old Max Import Power Demand Ch1
132	Old Max Import Power Demand Ch2
133	Old Max Import Power Demand Ch3
134	Old Max Import Power Demand Ch4

Parameter No	Parameters
135	Old Max Export Power Demand Ch1
136	Old Max Export Power Demand Ch2
137	Old Max Export Power Demand Ch3
138	Old Max Export Power Demand Ch4
139	Old Max Import Current Demand Ch1
140	Old Max Import Current Demand Ch2
141	Old Max Import Current Demand Ch3
142	Old Max Import Current Demand Ch4
143	Old Max Export Current Demand Ch1
144	Old Max Export Current Demand Ch2
145	Old Max Export Current Demand Ch3
146	Old Max Export Current Demand Ch4
147	Old On Hour
148	Old Run Hour Ch1
149	Old Run Hour Ch2
150	Old Run Hour Ch3
151	Old Run Hour Ch4
152	Old No. of Interruptions
153	Energy Import Ch1 OF
154	Energy Import Ch2 OF
155	Energy Import Ch3 OF
156	Energy Import Ch4 OF
157	Energy Export Ch1 OF
158	Energy Export Ch2 OF
159	Energy Export Ch3 OF
160	Energy Export Ch4 OF

TABLE : 3 Continued...

Parameter No	Parameters
161	Total Import Energy OF
162	Total Export Energy OF
163	AH Import Ch1 OF
164	AH Import Ch2 OF
165	AH Import Ch3 OF
166	AH Import Ch4 OF
167	AH Export Ch1 OF
168	AH Export Ch2 OF
169	AH Export Ch3 OF
170	AH Export Ch4 OF
171	Total Import AH OF
172	Total Export AH OF
173	Old AH Import Ch1 OF
174	Old AH Import Ch2 OF
175	Old AH Import Ch3 OF
176	Old AH Import Ch4 OF
177	Old AH Export Ch1 OF
178	Old AH Export Ch2 OF
179	Old AH Export Ch3 OF
180	Old AH Export Ch4 OF

3. Installation

Mounting is by four side clamps. Slide the side clamps through side slot till side clamp gets firmly locked in a groove (refer figure). Consideration should be given to the space required behind the instrument to allow for bends in the connection cables.

As the front of the enclosure conforms to IP54, it is protected from water spray from all directions. Additional protection to the panel may be obtained by the use of an optional gasket. The terminals at the rear of the product should be protected from liquids.

The instrument should be mounted in a reasonably stable ambient temperature and where the operating temperature is within the range -10° to 55° C. Vibration should be kept to a minimum and the product should not be mounted where it

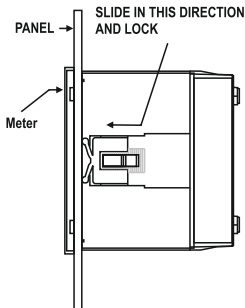

Caution

1. In the interest of safety and functionality of this product must be installed by a qualified engineer, abiding by any local regulations.
2. Voltages dangerous to human life are present at some of the terminal connections of this unit. Ensure that all supplies are de-energised before attempting any connection or disconnection.
3. These products do not have fuses, therefore external fuses must be used to ensure safety under fault conditions.

3,1 EMC Installation Requirements

This product has been designed to meet the certification of the EU directives when installed to a good code of practice for EMC in industrial environments, e.g

1. Screened output and low signal inputs leads or have provision for fitting RF suppression components, such as ferrite absorbers, line filters etc. in the event that RF fields cause problems.

Note: It is good practice to install sensitive electronic instruments that are performing critical functions, in EMC enclosures that protect against electrical interference which could cause a disturbance in function.

2. Avoid routing leads alongside cables and products that are or could be a source of interference.
3. To protect the product against permanent damage, surge transients must be limited to 2kV pk. It is good practice to suppress differential surges to 2kV at the source. The unit has been designed to automatically recover in the event of a high level of transients. In extreme circumstances it may be necessary to temporarily disconnect the auxiliary supply for a period greater than 5 second to restore correct operation.

3,2 Case Dimensions and Panel Cut-out

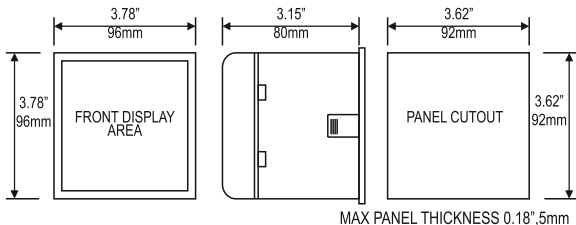

3,3 Wiring

Input connections are made directly to screw-type terminals with indirect wire pressure. Numbering is clearly marked in the plastic moulding. Choice of cable should meet local regulations. Terminal for both current and voltage inputs will accept upto 3mm² x 2 diameter cables.

Note: It is recommended to use wire with lug for connection with meter.

3,4 Auxiliary Supply

The instrument should ideally be powered from a dedicated supply, however it may be powered from the signal source, provided the source remains within the limits of the chosen auxiliary voltage.

3,5 Fusing

It is recommended that the voltage line is fitted with 1A HRC fuses.

3,6 Earth/Ground Connections

For safety reasons, ensure proper grounding of the panel in accordance with local regulations.

4. Connection Diagram

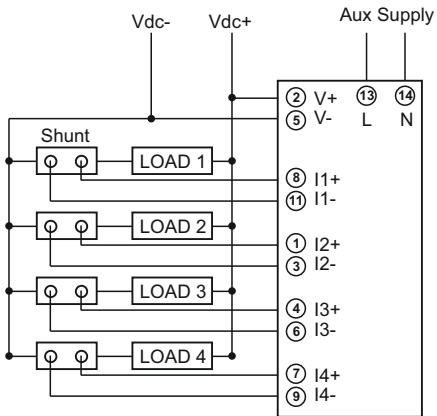

5. Parameter Editing Guide (Unless specified otherwise, follow these steps to edit any value in setup screens.)

- 1) Use **←** key to enter editing mode. A blinking decimal point will be displayed as cursor.
- 2) Use **▲** & **▼** keys to increase or decrease the digit values respectively, or cycle through options.
- 3) Use **←** key to go to the next cursor position.
- 4) Use **←** key to confirm the value and finish editing.
- 5) Longpress **▲** & **▼** together to go to the previous menu.
The same can be achieved by going to quit screen and pressing **←** key.
- 6) If user inputs values out of the limits specified, they are brought to the limit values automatically by the meter and shown at value confirmation. These limits are mentioned besides the corresponding screens on the flowchart starting from next page.
- 7) Any exceptions and special cases are also marked with * and explained on the bottom of the page.
- 8) Number of 'x's denote displayed digits on the screen which the user can edit.

There are two types of parameters in the setup screens. 1) Numeric & 2) Options.

Example 1: If a user want to change a numeric value he/she will have to follow the steps mentioned below.

Parameters having numeric value can be identified by the mentioned range parameter besides the corresponding screen in the flowchart. We'll take example of V-FS screen.

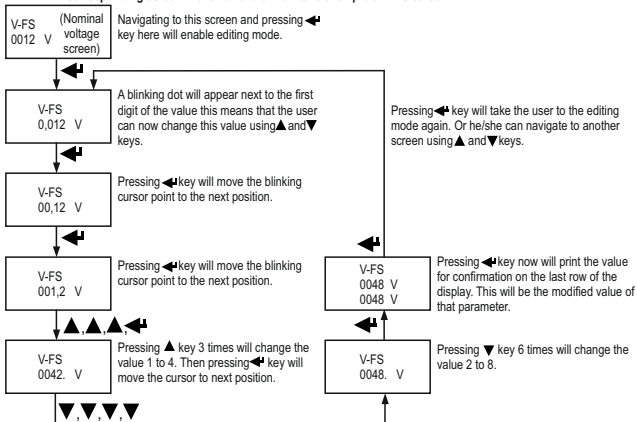

Example 2: If a user want to change a parameter with options he/she will have to follow the steps mentioned below. Parameters having options can be identified by the mentioned options parameter besides the corresponding screen in the flowchart. We'll take example of parity screen.

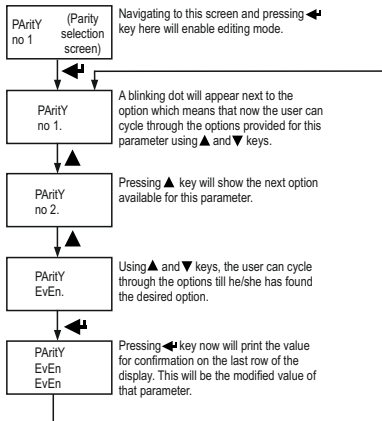

Pressing **←** key will take the user to the editing mode again. Or he/she can navigate to another screen using **▲** and **▼** keys.

6. Setup Screens (Flowchart)

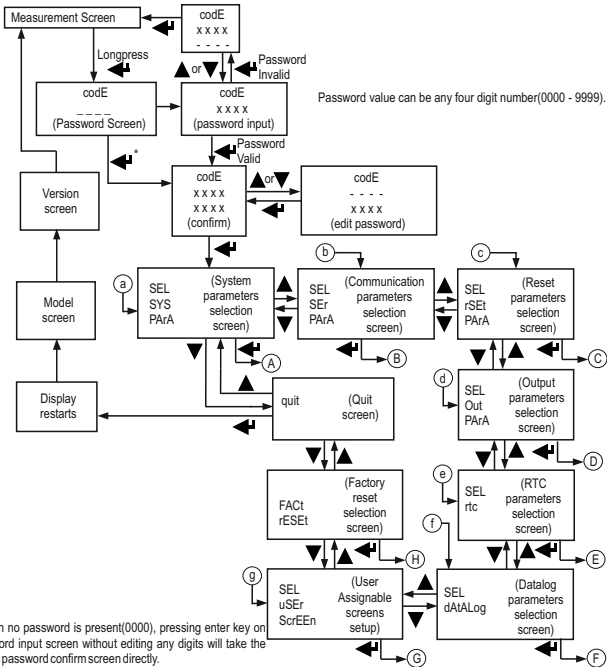

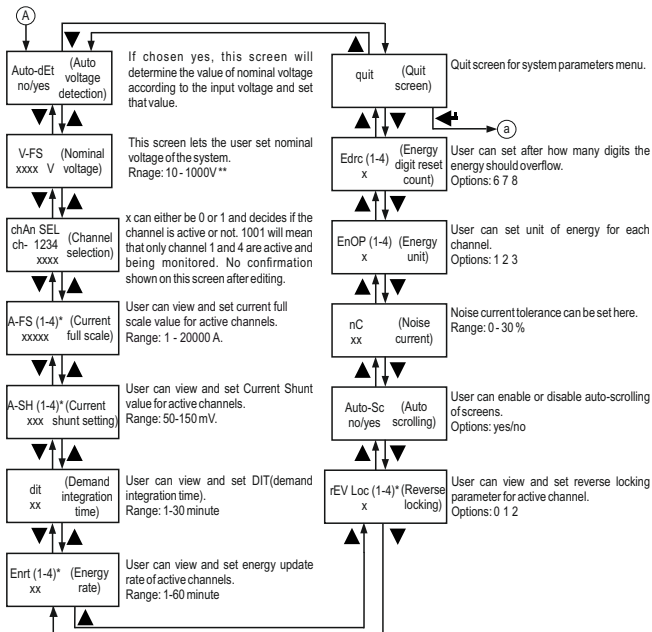

* channel parameters are only shown for active channels. User can cycle through them one-by-one using ▼ and ▲ keys.

** Value ranges according to the model. (10 - 60V, 61 - 200V, 201 - 1000V)

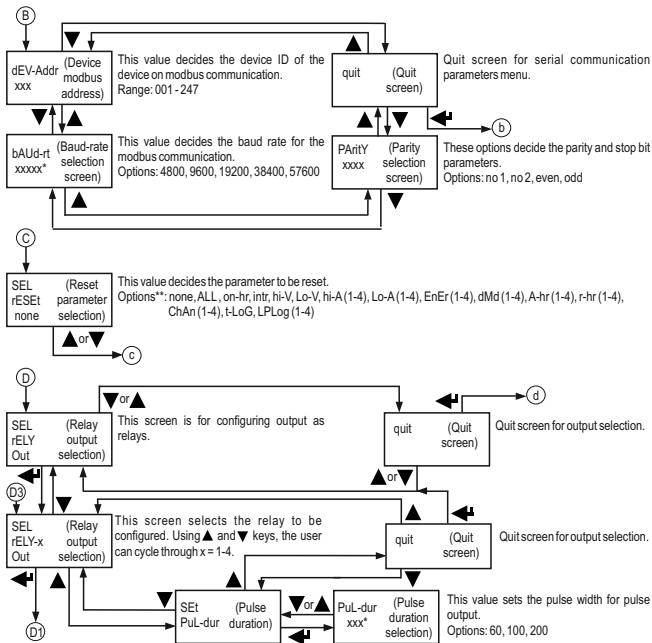

* These options have values with varying number of digits.

** The options with individual channel parameters in this list are displayed regardless of if the channel is active or not.

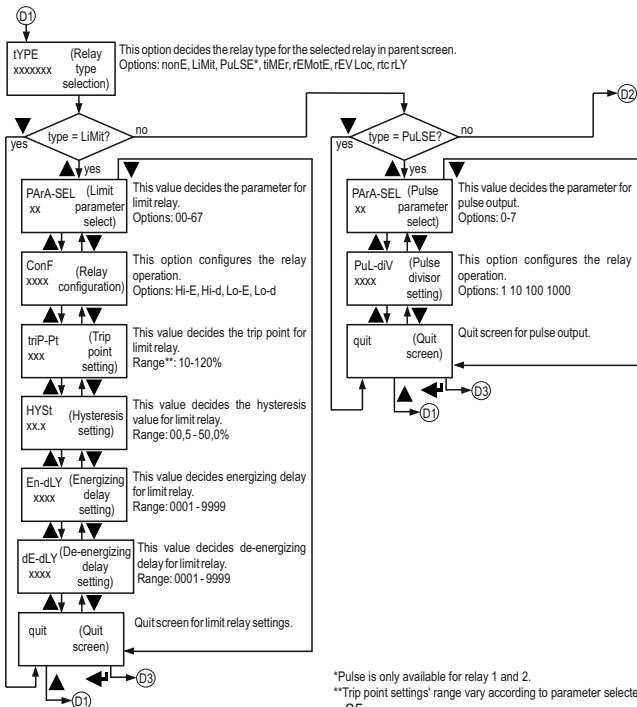

*Pulse is only available for relay 1 and 2.

**Trip point settings' range vary according to parameter selected.

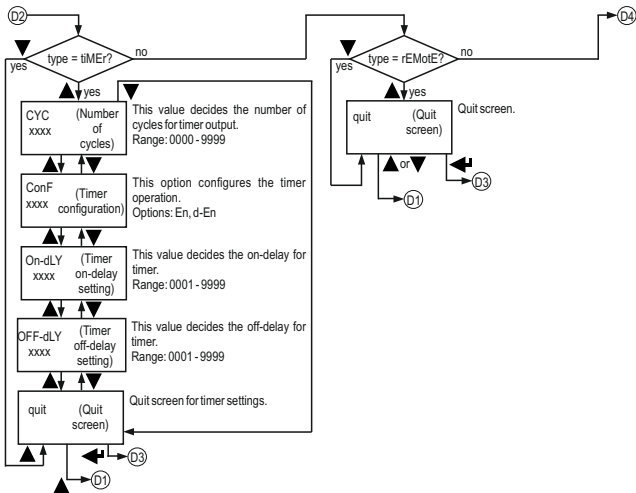

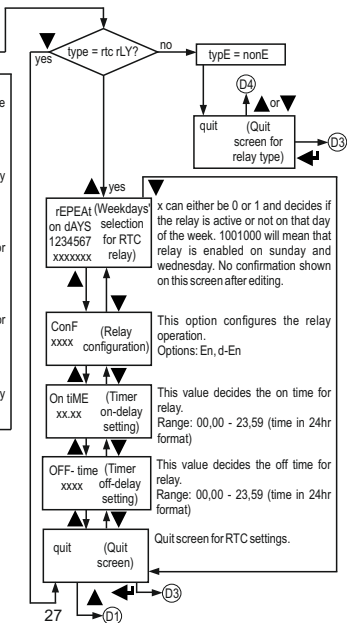
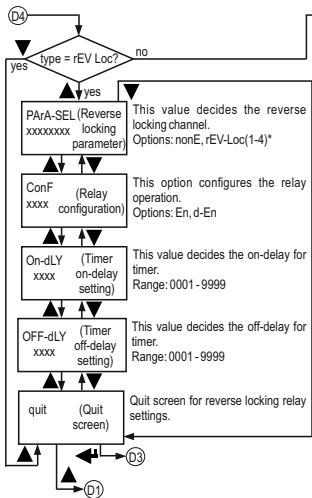

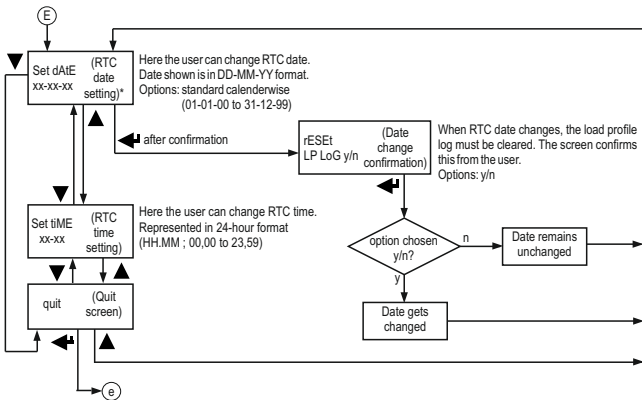

* When changing RTC date, the load profile log also gets cleared. There is a confirmation screen for load profile log reset before date change confirmation.

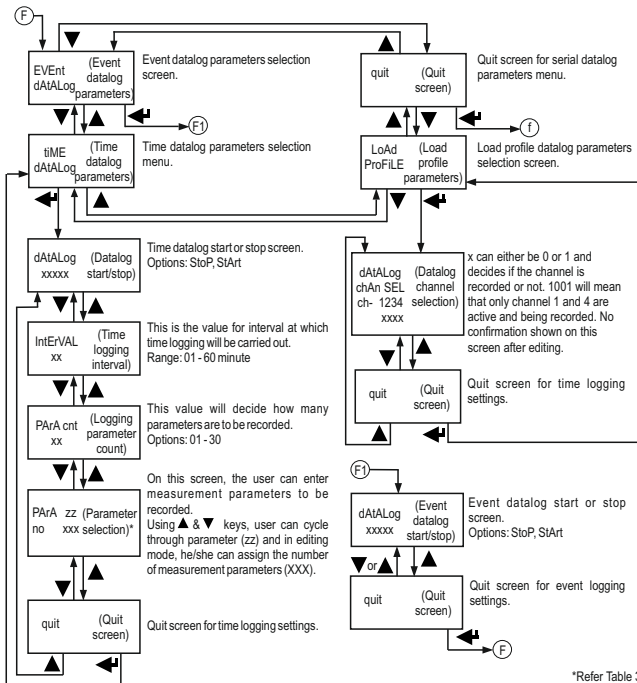

*Refer Table 3

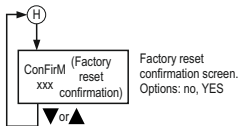
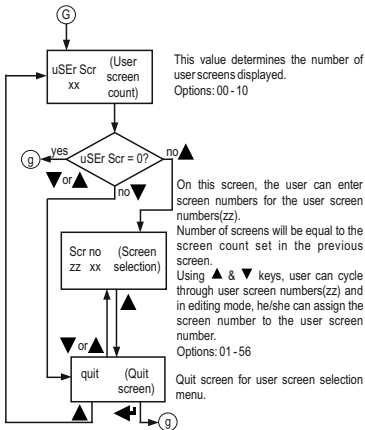

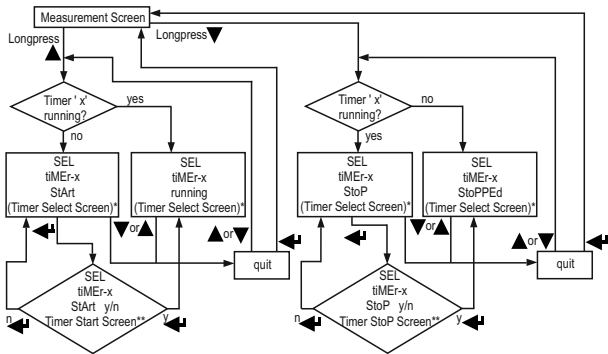

* Value of 'x' can be changed from 1-4 depending on the timers selected in output configuration settings using ▲ and ▼ keys .

** Use ▲ and ▼ keys to select y(yes) or n(no).

7. Programming

The following sections comprise step by step procedures for configuring the DC energy meter according to user requirements. To access the set-up screens press and hold  key for 2 second. This will take the user into the password input screen (Section 7.1).

7.1. Password Protection

Password protection can be enabled to prevent unauthorised access to setup screens.



By default password protection is disabled.

To enable password protection the user need to set a password other than 0000.

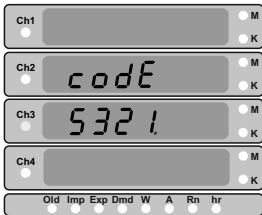
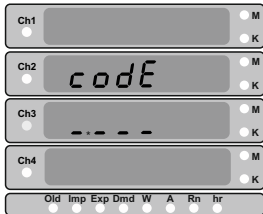
Note: The flashing decimal point indicates the cursor position, a steady decimal point will be present to identify the scaling of the number until the cursor position coincides with steady decimal point position. At this stage the decimal point will flash.



Enter Password, prompt for first digit. The symbol * at the first digit denotes that the decimal Point will be flashing. In special case where the Password is "0000" pressing the key when prompted for the first digit will advance to "Password confirmed" screen.

Use  &  keys to increase or decrease the value of the digit. The value can go from 0 to 9 and will wrap around. After reaching the desired digit on display, press  key to confirm and go to the next digit. The decimal point next to the 2nd digit will start flashing.

Following the same steps as above enter all four digits. Pressing enter key after the last digit will take the user to password confirmation screen.

Now when the user presses  key, there are two possibilities for the next screen.

1) If the entered password is correct the display will show the password on the fourth row.

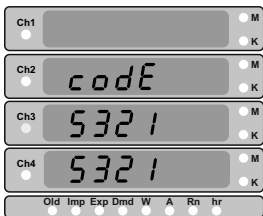

Pressing the ▲ or ▼ key will take the user to edit password mode. New password can be set from here. Editing method is the same as explained above.

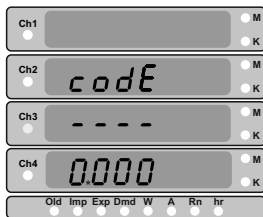

After editing, when pressed ◀ key after last digit, the new password will be shown on 3rd and 4th row. This means that the new password is set.

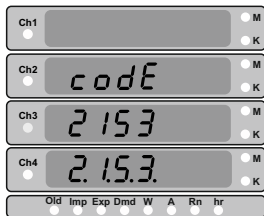

Now pressing ◀ key will let the user enter the setup menu. And pressing ▲ or ▼ key will allow him/her edit the password again.

2) If the entered password does not match with the current password, the display will show wrong password screen.

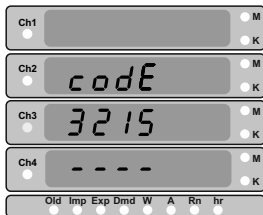

Pressing ◀ key on this screen will take the user to measurement screen. Pressing ▲ or ▼ key will prompt him to enter the password again.

7.2 System Parameter Selection Screen

The first menu in the setup menu is the system parameters menu. In this menu, the user can configure the parameters related to the system within which the instrument will be used and different measurement parameter configurations. The display text on this screen is shown.

```
SEL
SYS
PARA
```

Pressing ▲ or ▼ keys on this screen will navigate through different menu screens as shown in flowchart.

7.2.1 Auto Voltage Detection

This screen can be used to set the value of nominal voltage according to the input voltage.

```
Auto-dEt
```

Table-4

Nominal Voltage	Input Voltage
10 - 60V Meter	
12	< 18V
24	>= 18 & <36
48	>= 36 & < 56
60	> 56
61 - 200V Meter	
72	< 90
110	>= 90 & < 135
160	>= 135 & < 180
200	> 180
201 - 1000V Meter	
220	< 235
380	>= 235 & < 450
500	>= 450 & < 600
750	>= 600 & < 800
1000	> 800

Choosing "yes" in the options will set the nominal voltage value. Table-4 shows different nominal voltage values set for different input voltage values.

7.2.2 Nominal Voltage

On this screen the user can set the value of the nominal voltage (voltage full scale V-FS) value for the meter. Range for this value can be any of the three.

```
U-FS
```

- 1) 10-60V
- 2) 61-200V
- 3) 201-1000V

Note: Changing this value will perform a "reset all" operation. i.e. all stored parameters values will be erased.

7.2.3 Channel Selection

This screen is used to select active channels. The meter will only monitor the channels set as active. The numbers "1234" on the third row denotes channels 1 to 4 respectively and the digits '1' or '0' below it denotes whether that channel is active or not. Pressing ◀ key here will allow the user to edit the value on the 4th row of the display. The user can only enter either '0' or '1'.

```
chAn SEL
ch- 1234
    1111
```

7.2.4 Current Full Scale Value

The nominal full scale current that will be displayed as the channel currents. This screen enables the user to display the channel currents without any shunt ratings, the values displayed here represents the currents in ampere. The range for these values is 1-20000 A. This screen will show settings for active channels only & channel LED will turn green for selected channel.

```
A-FS I
```



Note: Changing this value will perform a "reset channel" operation. i.e. all stored parameter values for this specific channel will be erased.

7.2.5 Current Shunt Value

This value is the voltage drop created by the shunt on the channel. This value can be set in range of 50 - 150 mV. This screen will show settings for active channels only & channel LED will turn green for selected channel.

A-5H1

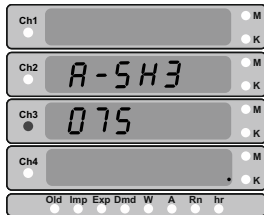

Note: Changing this value will perform a "reset channel" operation. i.e. all stored parameter values for this specific channel will be erased.

7.2.6 Demand Integration Time

This value is the period in minutes over which the current and the power readings are to be integrated. The range for this value is 1 - 30 minutes.

d it

7.2.7 Energy Rate

This value denotes the energy update rate in minutes and can range from 1 - 60 minutes. The energy will be updated on modbus location from 30171 to 30201 and 44267 to 44297 after the time set on this screen. The setting will only be shown for the active channels and the corresponding channel LED will glow green.

Enrt

7.2.8 Reverse Locking

This screen shows the parameter for reverse locking of channels. Reverse locking is when the current or power is in the opposite direction of the desired direction, the energy and/or ampere-hour accumulation is stopped for the related channel. The setting will only be shown for the active channels and the corresponding channel LED will glow green. The parameter options are shown below. The energy locking will depend on power direction and the ampere-hour locking will depend on current direction.

rEU Loc

Table-5

Code	Value
0	Rev Lock Off
1	Positive / Import
2	Negative / Export

7.2.9 Auto Scrolling

This screen allows user to enable or disable automatic screen scrolling. This feature is disabled by default. The options for this parameter are "yes" or "no".

Auto-Sc

7.2.10 Noise Current

This screen allows user to set low noise current cutoff. The range for this value is 0 - 30 % of nominal value. By default it is set to 0 %.

nC

7.2.11 Energy Output

This value lets the user decides the energy measurement unit according to the individual requirements. The user can set the unit to Wh, kWh or Mwh. The same is applicable to all types of energy. The options for this setting are 1 2 or 3 which denote the unit as shown in the table-6.

EnoP

Table-6

Code	Unit
1	Wh
2	kWh
3	Mwh

Note: Energy measurement in "Wh" unit is disabled when the nominal power is > 60 kW. Meter will automatically switch to "kWh" if this condition is true.

7.2.12 Energy Digit Reset Count

This screen enables user to set maximum energy count after which energy will roll over to zero. The options for this setting can be 6 7 or 8 digits.

Edrc

7.3 Communication Parameter SelectionScreen

This menu contains different communication parameters like device address baud rate etc. These settings are applicable only for modbus.

For USB, the fixed settings are baud rate - 57600.

Parity - no parity, 2 stop bits, Address - 1.

SEL
SER
PARA

7.3.1 Address Setting

This value decides the device address for modbus communication. This value can range from 001 - 247.

dEU-Addr

7.3.2 Baud Rate

This value decides the RS485 baud rate. The options for this setting are 4800, 9600, 19200, 38400 and 57600. Default value is set as 9600.

baud-rb

7.3.3 Parity

This value decides the parity bit and the number of stop bits for RS485 communication. The options for this value are as following.

no 1: no parity, 1 stop bit

no 2: no parity, 2 stop bits

even: even parity, 1 stop bit

odd: odd parity, 1 stop bit

By default, the value for this parameter is set as no 1.

PARity

7.4 Reset Parameter Selection

This screen allows user to reset various stored parameters. When reset is performed, current register values are moved to corresponding "old" registers. The different reset parameters are listed below.

none:	No parameter is reset
ALL:	All parameters are reset
on-hr:	On hour is reset
intr:	Interruptions is reset
hi-V:	Higher voltage is reset
Lo-V:	Lower voltage is reset
hi-A*:	Higher current is reset
Lo-A*:	Lower current is reset
EnEr*:	Energy is reset
dMd*:	Demand is reset
A-hr*:	Ampere hour is reset
r-hr*:	Run hour is reset
ChAn*:	Selected channel data is reset
t-LoG:	Timelog is reset
LPLog*:	Load profile log is reset

*These parameters reset channelwise.

7.5 Output Parameter Selection

In this menu the user can configure different output available from the meter.

SEL
RESET

SEL
Out
PARA

7.5.1 Select Relay Output

On this screen the user can select relay as the output option and can decide which of the available relay to be used for his/her application. Number of available relays depend on the order code (see datasheet for more information).

On selecting a relay, the user will be taken to the type selection screen, which prompts him to select an option out of seven available. The options are as following.

- 1) None
- 2) Limit
- 3) Pulse
- 4) Timer
- 5) Remote
- 6) Reverse Lock
- 7) RTC relay

The option "none" implies that the relay is disabled.

SEL
RELY
Out

TYPE

7.5.1.1 Limit Relay Configuration

These parameters will decide the operation of limit relay.

7.5.1.1.1 Limit Parameter

The user can assign any one out of available options for limit relay. The explanation of these options is given in table-8.

PARA-SEL

7.5.1.1.2 Limit Configuration

This screen allows the user to select relay configuration out of 4 available options.

- 1) Hi-E
- 2) Hi-d
- 3) Lo-E
- 4) Lo-d

CONF

7.5.1.1.3 Trip Point

This is the value for selected parameter limit which is used as a reference for relay tripping. It is represented as percentage value.

`trIP-Pt`

Percentage value is calculated on nominal value. Different ranges for different parameters are shown in table-8.

Press Enter key to edit trip point. Then press ▲ or ▼ key to select positive or negative tripping point then press Enter key to edit trip point digit. Pressing ▲ key increments digit value & pressing ▼ key decrements digit value. Press Enter key to confirm newly changed trip point.

7.5.1.1.4 Hysteresis

Hysteresis is the value below high alarm trip point or above low alarm trip point, which when crossed by the measured parameter, resets the relay to its position before tripping. The value of hysteresis can range from 0,5 to 50% and it gets calculated on trip point value.

`HYSt`

7.5.1.1.5 Energizing Delay

Energizing delay is the time in seconds taken by the relay before tripping after an alarm condition has occurred. The value for this parameter can range from 0001 to 9999.

`En-dLy`

7.5.1.1.6 De-energizing Delay

De-energizing delay is the time in seconds taken by the relay before coming out of the trip state, after a normal condition has observed. The value for this parameter can range from 0001 to 9999.

`dE-dLy`

7.5.1.2 Pulse Relay Configuration

Pulse relay can be used with a mechanical counter to measure energy. It is a potential free, very fast acting relay contact.

7.5.1.2.1 Pulse Parameter Selection

This parameter decides on which measurement parameter, the pulses will be occurring. The options for this setting are 0-7 as explained in table-7.

`PARA-SEL`

Table-7

Code	Configuration
0	Import Energy ch1
1	Import Energy ch2
2	Import Energy ch3
3	Import Energy ch4
4	Export Energy ch1
5	Export Energy ch2
6	Export Energy ch3
7	Export Energy ch4

7.5.1.2.2 Pulse Divisor

This parameter decides after how many units of energy a pulse should appear at output.

`PUL-div`

7.5.1.2.3 Pulse Duration

This parameter decides the width of the output pulse. The options for this parameter are 60, 100 and 200 ms.

`PUL-dur`

7.5.1.3 Timer

This menu contains the parameters for timer output configuration.

7.5.1.3.1 Number of Cycles

This value decides how many times the timer will repeat the switching after once started. If this value is set as 0, timer will keep repeating the cycles until stopped.

`CYC`

7.5.1.3.2 Timer Configuration

Timer configuration decides the relay configuration for timer output. There are two options for this parameter.

CONF

- 1) Energize on start
- 2) De-energize on start

7.5.1.3.3 On Delay

On delay is the time in seconds taken by the relay in timer configuration before tripping after it is started. The value for this parameter can range from 0001 to 9999.

On-dLY

7.5.1.3.4 Off Delay

Off delay is the time in seconds taken by the relay in timer configuration before coming out of the trip state, after it has tripped. The value for this parameter can range from 0001 to 9999.

OFF-dLY

7.5.1.4 Remote Operation

In this mode the meter configures the relay to be controlled via Rs485 modbus communication.

7.5.1.5 Reverse Locking Relay

This relay can be used to control some instrument when reverse polarity of current or powers is observed.

7.5.1.5.1 Parameter Selection

This parameter decides on which channel's reverse locking parameter, the relay should trip. There are four options for this parameter.

- 1) none
- 2) rev lock 1
- 3) rev lock 2
- 4) rev lock 3
- 5) rev lock 4

PARA-SEL

The number of options on this screen will depend on how many channels are configured for reverse locking in system parameters menu

7.5.1.5.2 Relay Configuration

This parameter decides the relay configuration for relay in reverse locking mode. There are two options for this parameter.

CONF

- 1) Energize
- 2) De-energize

7.5.1.5.3 On Delay

On delay is the time in seconds taken by the relay in reverse locking configuration before tripping, after a reverse locking is observed. The value for this parameter can range from 0001 to 9999.

On-dLY

7.5.1.5.4 Off Delay

Off delay is the time in seconds taken by the relay in reverse locking configuration, after a normal condition has observed. The value for this parameter can range from 0001 to 9999.

OFF-dLY

7.5.1.6 RTC Relay

RTC relay can be used to control some instrument automatically over the period of a week repetitively.

7.5.1.6.1 Weekdays selection

On this screen, the user can select on which days the relay should work and on what days it should not work.

The numbers on the third row of display denotes days of the week starting from Sunday; i.e. 2 is Monday, 3 is Tuesday and so on. The numbers on the last row denotes if the relay should work on that day corresponding to the number above that digit or not. 1 means the relay works on that day and 0 means it does not work.

```
REPERRt
on dRYS
 1234567
1000111
```

7.5.1.6.2 Relay Configuration

This parameter decides the relay configuration for relay in reverse locking mode. There are two options for this parameter.

CONF

- 1) Energize
- 2) De-energize

7.5.1.6.3 On Time

On time is the time on which the relay becomes active. This time is represented in 24 hour format HH:MM. The range for this parameter's value is 00:00 to 23:59.

On t inE

7.5.1.6.4 Off Time

Off time is the time on which the relay deactivates. This time is represented in 24 hour format HH:MM. The range for this parameter's value is 00:00 to 23:59.

oFFt inE

7.6 RTC parameters Setup

This menu allows user to change RTC date and time

SEL
rtc

7.6.1 Date Setup

User can change the system date from this screen. The date is displayed in DD-MM-YY format and range is 01-01-00 to 31-12-99.

SEt dAtE

After editing the date user will be prompted that this change will cause a load profile reset. If user confirms this then only the new date will be updated in RTC.

rESEt
LP LoG

7.6.2 Time Setup

On this screen the user can change RTC time. Time is displayed in HH.MM format. value ranges from 00,00 to 23,59

SEt t inE

7.7 Datalog Setup Screens

In this menu, the user can set various parameters related to datalogging.

SEL
dAtAALoG

7.7.1 Event Datalog Setup

In this menu, the user can configure settings related to event datalogging.

EUENt
dAtAALoG

7.7.1.1 Event Datalog Start/Stop

In this menu, the user can start or stop event datalogging.

dAtAALoG

7.7.2 Time Datalog Setup

In this menu, the user can set parameters related to time datalogging.

t inE
dAtAALoG

7.7.2.1 Time Datalog Start/Stop

In this menu, the user can start or stop time datalogging.

dAtAALoG

Note: When this option is set to start, the user will not be allowed to edit other parameters related to time datalog.

7.7.2.2 Interval Selection

This value decides the time interval between two successive time datalog entries. Range for this value is 01-60 minute.

IntErVAL

7.7.2.3 Parameter Count

This value decides how many parameters will be logged in time logging. The value range is 01-30

PARA cnt

7.7.2.4 Parameter Selection

On this screen the user can select the measurement parameters to be recorded.

Parameter will scroll through parameter count set in previous screen. In editing mode, the user can see/change the measurement parameter no.

The range for this is 000 - 180.

PARA 05
no 123

7.7.3 Load Profile Setup

In this menu, the user can edit the parameters related to load profile logging.

LOAD
PROF,LE

7.7.3.1 Datalog Channel Selection

On this screen, the user can select the channels for load profile logging. This screen works in similar ways as channel selection screen in system parameters and weekdays selection in RTC relay. The numbers "1234" on the third row denote four channels and options '1' or '0' directly below them denote whether that channel is load profile logged or not respectively.

dAtALog
chAn SEL
ch- 1234
1111

7.8 User Assignable Screen Setup

In this menu, the user can configure the user screens.

SEL
USER
SCREEN

7.8.1 Number of User Screens

On this screen, the user can set the number of user screens to be displayed.

Options for this parameter are 00 - 10. The value 00 will denote that the user screens are disabled and the user screen selection screen will not show up.

USER Scr

7.8.1.1 User Screen no. Selection

This screen shows two parameters.

- 1) Screen
- 2) Screen number

The screen will scroll through the number of screen selected in previous screen and the user can see/change the screen number in editing mode. The range for this value is 01 - 56. Refer table-3.

Scr no

7.9 Factory Reset

In this menu, the user can factory reset the meter. This will erase all data from the meter and set all setup parameters to their default values.

FACT
RESET

7.9.1 Factory Reset Confirmation

This screen has the options, no/yes. Selecting 'yes' will start the factory reset process and selecting 'no' will do nothing.

CONFIRM

Table-8

Parameter No	Parameter	Range	Parameter No	Parameter	Range
0	None	-----	25	Max Export Current Demand Ch2	10 - 120%
1	Voltage	$\pm 10 - \pm 120\%$	26	Amp Hour Imp Ch2	10 - 9999999
2	Current Ch 1	$\pm 10 - \pm 120\%$	27	Amp Hour Exp Ch2	10 - 9999999
3	Power Ch1	$\pm 10 - \pm 120\%$	28	Energy Imp Ch2	10 - 9999999
4	Power Imp Demand Ch1	10 - 120%	29	Energy Exp Ch2	10 - 9999999
5	Power Exp Demand Ch1	10 - 120%	30	Current Ch 3	$\pm 10 - \pm 120\%$
6	Import Current Demand Ch1	10 - 120%	31	Power Ch3	$\pm 10 - \pm 120\%$
7	Export Current Demand Ch1	10 - 120%	32	Power Imp Demand Ch3	10 - 120%
8	Power Max Imp Demand Ch1	10 - 120%	33	Power Exp Demand Ch3	10 - 120%
9	Power Max Exp Demand Ch1	10 - 120%	34	Import Current Demand Ch3	10 - 120%
10	Max Import Current Demand Ch1	10 - 120%	35	Export Current Demand Ch3	10 - 120%
11	Max Export Current Demand Ch1	10 - 120%	36	Power Max Imp Demand Ch3	10 - 120%
12	Amp Hour Imp Ch1	10 - 9999999	37	Power Max Exp Demand Ch3	10 - 120%
13	Amp Hour Exp Ch1	10 - 9999999	38	Max Import Current Demand Ch3	10 - 120%
14	Energy Imp Ch1	10 - 9999999	39	Max Export Current Demand Ch3	10 - 120%
15	Energy Exp Ch1	10 - 9999999	40	Amp Hour Imp Ch3	10 - 9999999
16	Current Ch 2	$\pm 10 - \pm 120\%$	41	Amp Hour Exp Ch3	10 - 9999999
17	Power Ch2	$\pm 10 - \pm 120\%$	42	Energy Imp Ch3	10 - 9999999
18	Power Imp Demand Ch2	10 - 120%	43	Energy Exp Ch3	10 - 9999999
19	Power Exp Demand Ch2	10 - 120%	44	Current Ch 4	$\pm 10 - \pm 120\%$
20	Import Current Demand Ch2	10 - 120%	45	Power Ch4	$\pm 10 - \pm 120\%$
21	Export Current Demand Ch2	10 - 120%	46	Power Imp Demand Ch4	10 - 120%
22	Power Max Imp Demand Ch2	10 - 120%	47	Power Exp Demand Ch4	10 - 120%
23	Power Max Exp Demand Ch2	10 - 120%	48	Import Current Demand Ch4	10 - 120%
24	Max Import Current Demand Ch2	10 - 120%	49	Export Current Demand Ch4	10 - 120%

Parameter No	Parameter	Range
50	Power Max Imp Demand Ch4	10 - 120%
51	Power Max Exp Demand Ch4	10 - 120%
52	Max Import Current Demand Ch4	10 - 120%
53	Max Export Current Demand Ch4	10 - 120%
54	Amp Hour Imp Ch4	10 - 9999999
55	Amp Hour Exp Ch4	10 - 9999999
56	Energy Imp Ch4	10 - 9999999
57	Energy Exp Ch4	10 - 9999999
58	Total Import Power	10 - 120%
59	Total Export Power	10 - 120%
60	Total Import Power Demand	10 - 120%
61	Total Export Power Demand	10 - 120%
62	Total Import Current Demand	10 - 120%
63	Total Export Current Demand	10 - 120%
64	Total Import AH	10 - 9999999
65	Total Export AH	10 - 9999999
66	Total Import Energy	10 - 9999999
67	Total Export Energy	10 - 9999999

Note : - 1. Nominal power = $Nom V \times Nom I$
 2. Range in % of nominal value

8 Relay Output

8.1 Limit Relay

Limit relay can be used to monitor the measured parameter in comparison to a set limit.

Relay Configurations

A relay can be configured in one of the four modes given below.

- 1) Hi-E High alarm, energized relay
- 2) Hi-d High alarm, de-energized relay
- 3) Lo-E Low alarm, energized relay
- 4) Lo-d Low alarm, de-energized relay

High alarm relay means that it will go to alarm condition when the measured parameter is greater than the set limit and low alarm relay means it will go to alarm mode when measure parameter is less than the set limit.

Energized relay means that the relay switch will be closed in alarm condition and de-energized relay means that the switch will be open in alarm condition.

Trip Point

This parameter decides the limit for a particular measurement parameter, crossing which the relay goes into alarm mode. These values are defined in percentage of nominal value(except for energy and ampere hour parameters).

For high alarm configuration, the ranges are 10-120%.

For low alarm, configuration, the ranges are 10-100%.

For energy and ampere hour parameters the ranges are 10-9999999.

Example: If nominal voltage value is 48V and trip point is 60%, the absolute value of trip point will be 28,8V(60% of 48).

Hysteresis

Hysteresis is the offset value below high alarm trip point or above low alarm trip point, which when crossed by the measured parameter, resets the relay to its position before tripping i.e. normal condition.

The value of hysteresis can range from 0,5 to 50% and it gets calculated on trip point value.

Example: If trip point is 60% and hysteresis is 25%, then hysteresis value will be equal to 15%(25% of 60).

To get absolute value of hysteresis subtract this much part of nominal value from the trip point in case of high alarm or add this to the trip point value in case of low alarm.

Example:

Nominal value = 48 V,

Trip point (%) = 60%,

Hysteresis (%) = 25 %

Trip value = 60% of 48V = 28,8V

High alarm Hysteresis value = 25 % of 28,8 V = 7,2 V

So, relay will trip above 28,8 V & it will reset below 21,6 V (28,8 V - 7,2 V)

For negative values of trip point, calculations will be the same as positive trip point. Only a negative sign is applied to calculated hysteresis value.

Examples for Different Configurations

a) Trip point = 50%

Hysteresis = 50%

Absolute hysteresis value = 50% - (50% of 50)
= 25%

b) Trip point = -50%

Hysteresis = 50%

Absolute hysteresis value = - [50% - (50% of 50)]
= -25%

Energizing delay = 2s De-energizing delay = 3s

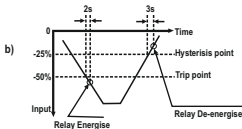
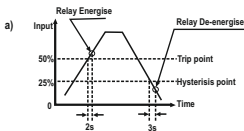
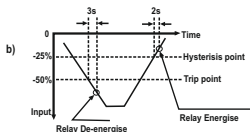
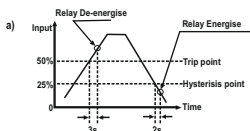
1) High alarm & Energised relay**2) High alarm & De-energised relay**

3) Low alarm & Energised relay

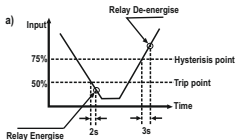

4) Low alarm & De-energised relay

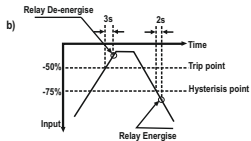
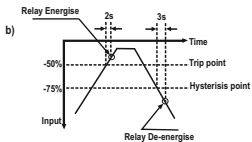
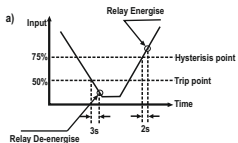

8.2 Pulse Output

Pulse Output is the potential free, very fast acting relay contact which can be used to drive an external mechanical counter for energy measurement. The Pulse Output can be configured to any of the parameter shown in table-7 through setup parameter screen.

TABLE : 9

For energy output in Wh

Pulse Rate		
Divisor	Pulse	Channel Power
1	1per Whr	Up to 3600W
	1per kWhr	above 3600W to 60kW
10	1per 10W/hr	Up to 3600W
	1per 10kWhr	above 3600W to 60kW
100	1per 100W/hr	Up to 3600W
	1per 100kWhr	above 3600W to 60kW
1000	1per 1000W/hr	Up to 3600W
	1per 1000kWhr	above 3600W to 60kW

NOTE: Energy Output changes from Wh to kWh if system power > 60kW

For energy output in kWh

Pulse Rate		
Divisor	Pulse	Channel Power
1	1per kWhr	Up to 3600kW
	1per MWhr	above 3600kW*

*Applicable to 61...200V and 201...1000V model

For energy output in MWh

Pulse Rate	
Divisor	Pulse
1	1per MWhr

8.3 Timer Output

Timer output can be used to operate the Relay in a cyclic manner. The user can define the ON period and OFF period and also the number of times this cycle is to be repeated. The number of Cycles (N) can be indefinite or 1 to 9999. The counting is shown on a measurement screen as explained before.

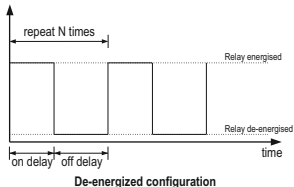
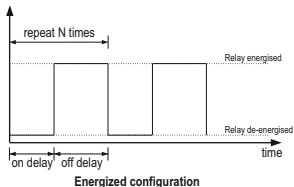

9. Specification :

Inputs Voltage

Nominal Input Voltage Range	1. 10-60 V 2. 61-200 V 3. 201-1000 V
Max continuous input voltage	125% of Nominal Value

Input Current

No. of Channels	4
Current Sensor	External Shunt
Shunt Setting Range	50mV to 150mV
Full scale Setting Range	1 to 20kA.
Max continuous input current	125% of Nominal value

Operating Measuring Ranges

Voltage	$\pm 2\%$ to $\pm 125\%$ of Nominal value
Current	$\pm 0.2\%$ to $\pm 125\%$ of Nominal value

Auxiliary Supply

Higher Aux	60V to 300V AC/DC, 45 to 65 Hz
Lower Aux	12V to 70V DC
Nominal Value	230V AC/DC 50/60 Hz for Higher Aux 24V DC for Lower Aux

Overload Indication	"-OL-" >126% of Nominal value (for voltage and current)
----------------------------	---

VA Burden:

Nominal input Voltage burden	< 0.4 W approx.
Nominal input Current burden	< 0.1 W approx. per channel
Auxiliary Supply burden	< 6 VA approx.

Accuracy

Reference condition	23°C \pm 2°C
Voltage	$\pm 0.5\%$ of Nominal Value (± 5 to $\pm 120\%$)
Current	$\pm 0.5\%$ of Nominal Value (± 5 to $\pm 120\%$)
Power	$\pm 0.5\%$ of Nominal Value (± 5 to $\pm 120\%$)
Energy	Class 1
Temperature drift	$\pm 0.05\%/^{\circ}\text{C}$

Note: Variation due to influence quantity is 100% of class index

Controls

User interface	3 push buttons
----------------	----------------

Display

Type	4 line 8-digit LED Display
Display Height	9 mm
Overload Indication	-oL- (Above 126% of nominal value)
Update rate	Approx. 1 sec

Display Range:

Voltage	0 to ± 9999
Current	0 to ± 9999
Power	0 to ± 9999
Energy (Import & Export)	0 to 99999999

Relay Output:

Max Load Voltage	250 VAC / 30 VDC
Max Load Current	5 A

Optional RS485 Communication:

Protocol	Modbus-RTU
Baud rate	4800, 9600, 19200, 38400, 57600 bps
Distance	1200 m

Overload withstand

Voltage input	2 x Rated Value (1s application repeated 10 times at 10s intervals)
Current input	20x Rated value for 1s Repeated 5 times at 5 min intervals

Applicable Standards

EMC Immunity	IEC 61326-2012 IEC 61000-4-3. 10V/m min – Level 3 Industrial Low level
Safety	IEC 61010-1-2010 , Permanently connected use IEC 60529 (IP 54)
IP for water & dust	
Pollution degree	2
Installation category	1000V CATII, 600V CATIII (Measuring Inputs) 300V CATIII (Power Supply)
Protective Class	2
High Voltage Test (AC 50Hz, 1 minute)	4.4 kV AC, Enclosure versus all electrical circuits 3.7 kV AC, Auxiliary Supply versus all other electrical circuits 2.2 kV AC, Measuring Terminals versus all other electrical circuits 2.2 kV AC, Voltage versus Current (optional) 2.2 kV AC, Relay versus Relay 2.2 kV AC, USB & RS485 versus all other electrical circuits

Environmental conditions

Operating temperature	-10 to +55 °C
Storage temperature	-20 to +70 °C
Relative humidity	0 .. 90 % RH (Non condensing)
Warm up time	3 minute (minimum)
Shock (As per IEC 60068-2-27)	15g in 3 planes
Vibration	10..55..10 Hz, 0.15mm amplitude
Number of Sweep Cycles	10 per axis

Dimensions & Weights :

Bezel Size	96 mm x 96 mm DIN 43 718
Panel Cut-out	92 + 0.8 mm x 92 + 0.8 mm
Overall Depth	80 mm
Weight	620 gm approx.

ModBus (RS 485) Option :

Protocol	ModBus (RS 485)
Baud Rate	57600, 38400, 19200, 9600 or 4800 (Programmable)
Parity	Odd or Even, with 1 stop bit, Or None with 1 or 2 stop bits

It is recommended that the wires used for connections to the instrument should have lugs soldered at the end. That is, the connections should be made with Lugged wires for secure connections. The Maximum diameter of the lug should be 7.0 mm and maximum thickness 3.5mm. Permissible cross section of the connections wires: <= 4.0 mm sqr. single wire or 2x2.5mm sqr. wire

10. Connection for Optional Pulse Output / RS 485 (rear view of Multifunction Meter):

1. RS 485 Output

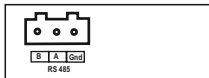

2. Relay1 & Relay2

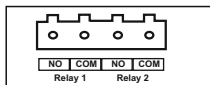

3. Relay1, Relay2, Relay3, Relay4

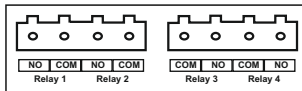

4. RS 485 Output with Relay1 & Relay2

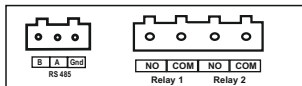

5. USB and RS 485

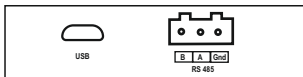

6. USB and Relay1 & Relay2

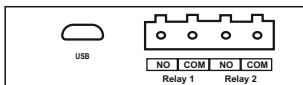

7. USB and Relay1, Relay2, Relay3, Relay4

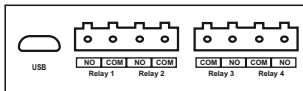

8. USB and RS 485 Output with Relay1 & Relay2

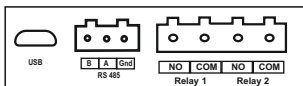

9. RS 485 Output with Relay1, Relay2, Relay3, Relay4

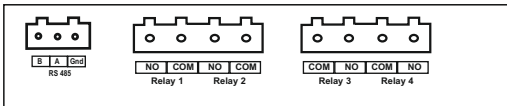

10. USB and RS 485 Output with Relay1, Relay2, Relay3, Relay4

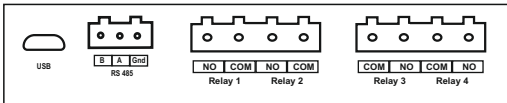

**LUMEL S.A.**

ul. Ślubicka 4, 65-127 Zielona Góra, Poland
tel.: +48 68 45 75 100, fax +48 68 45 75 508
www.lumel.com.pl

Technical support:

tel.: (+48 68) 45 75 143, 45 75 141, 45 75 144, 45 75 140
e-mail: export@lumel.com.pl

Export department:

tel.: (+48 68) 45 75 130, 45 75 131, 45 75 132
e-mail: export@lumel.com.pl

Calibration & Attestation:

e-mail: laboratorium@lumel.com.pl